

WEBB DECO Lighting Specification

灯具技术规格书

www.webbdecolighting.com

产品型号:

10.0716.E



基本参数:

- 材质: 灯体: 304#不锈钢面盖, ADC12压铸铝合金及6063挤压铝合金
反射器: 99.99%高纯度阳极氧化铝
出光玻璃: 15mm强化安全玻璃
密封圈: 耐老化耐水蒸气胶圈
紧固件: 304#不锈钢螺丝
- 表面处理: DuPont2层氟碳喷涂或环氧树脂粉喷涂
- 输入电压: AC220V 50Hz;
- 光源寿命: ≥9000小时;
- 防护等级: IP67, I类绝缘,
- 引出线: 灯具出线1.1m, 3×1mm²电缆线
- 环境温度: (-30℃, +45℃)
- 内箱尺寸:
- 外箱尺寸:

灯具尺寸图:

A: 一体式尺寸图

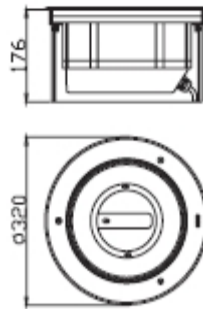

B: 分体式尺寸图

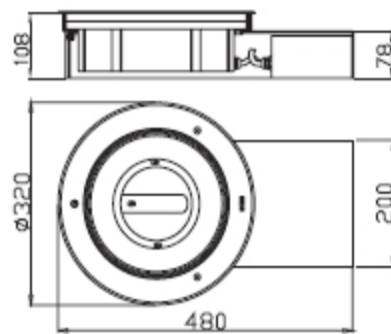

配光曲线图:

10.0716.1SE

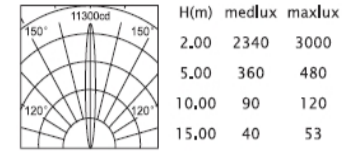

10.0716.2SE

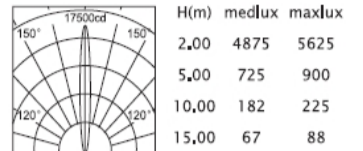

10.0716.1ME

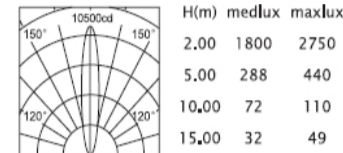

10.0716.2ME

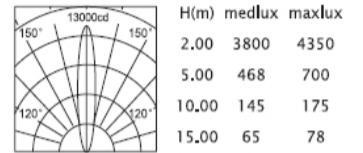

10.0716.1FE

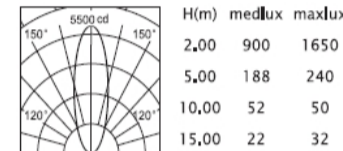

10.0716.2FE

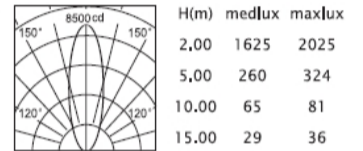

灯具技术规格书

www.webbdecolighting.com

产品型号说明:

10	0716	*	*	*
灯具种类	模具型号	光源代码	光束角	光源插入方式
10: 埋地灯		1: HIT 35W-G12/G8.5 2: HIT 70W-G12/G8.5 4: HST 70W-E27	S: 窄角5-10° M: 中角15-25° F: 宽角30-50° W: 超宽60-100°	E: 光源横插

灯具参数:

产品型号	光源	色温	灯头	光束角	光通量	灯具重量	包装毛重	图号
10.0716.1SE	HIT 35W	3000K/4200K	G8.5	8°	3300lm	8.8kg		A/B
10.0716.2SE	HIT 70W	3000K/4200K	G8.5	8°	6600lm	9.3kg		A/B
10.0716.1ME	HIT 35W	3000K/4200K	G8.5	15°	3300lm	8.8kg		A/B
10.0716.2ME	HIT 70W	3000K/4200K	G8.5	15°	6600lm	9.3kg		A/B
10.0716.1FE	HIT 35W	3000K/4200K	G8.5	30°	3300lm	8.8kg		A/B
10.0716.2FE	HIT 70W	3000K/4200K	G8.5	30°	6600lm	9.3kg		A/B

可选配件:

光学玻璃

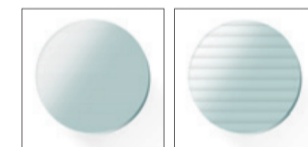

91.1051 91.1052

彩色镀膜玻璃



92.1011 92.1012 92.1013 92.1014 92.1015

方形面盖

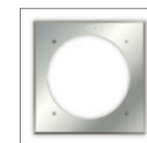

96.0716